

QOOZI

INSTALLATION GUIDE LUNO KK 035

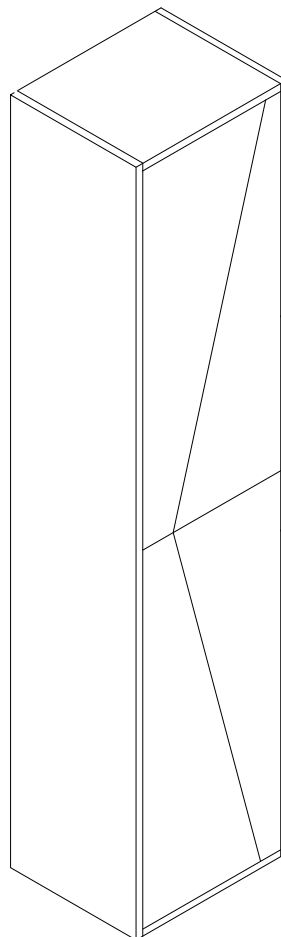

PRE-INSTALLATION - TOOLS REQUIRED

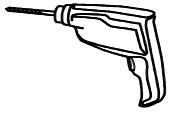

Drill

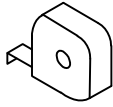

Measuring tape

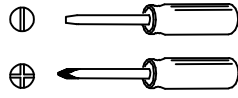

Screwdriver

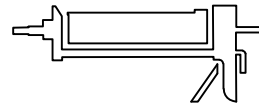

Silicone

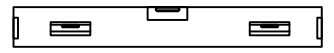

Level



Pencil

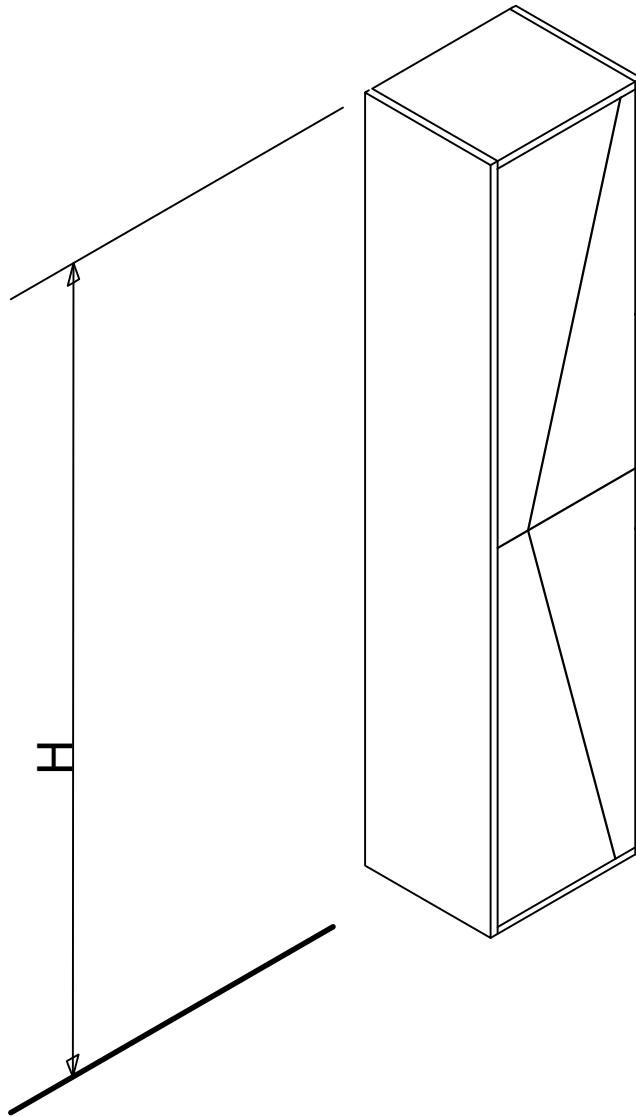

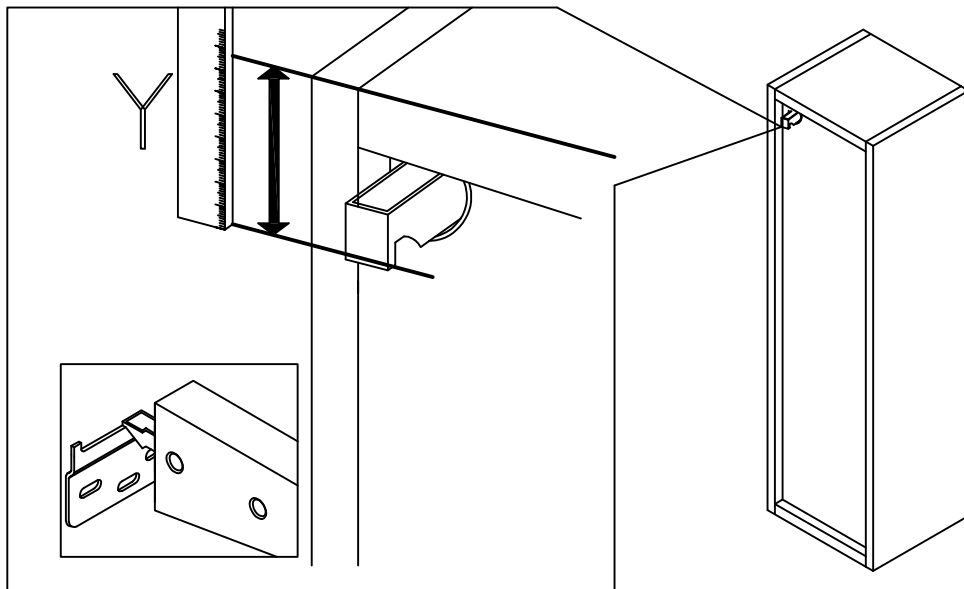

Please measure the "Y" size

2

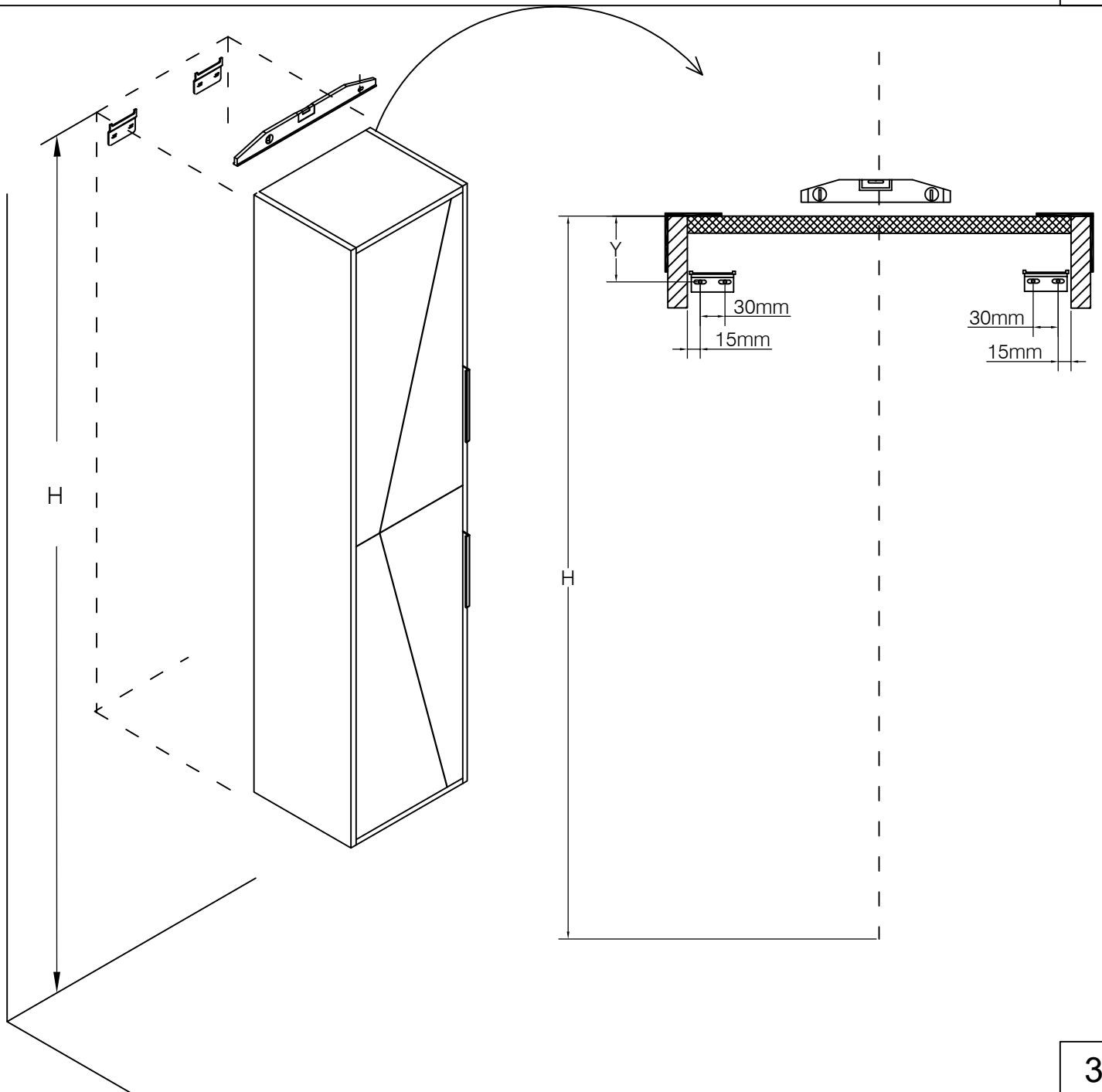

3

